

INNOVATIVE SOLUTIONS FOR CERAMIC AND STONE TILE

FLOOR DRAINS FOR UNCOUPLING MEMBRANES

Schluter®-KERDI-DRAIN-F and Schluter®-KERDI-DRAIN-A floor drains provide a simple and secure connection to uncoupling membranes at the top of the assembly via an integrated bonding flange. Thus, the membrane is applied entirely at the surface, with all water directed into the top of the drain.

Application and Function

Schluter®-KERDI-DRAIN-F and Schluter®-KERDI-DRAIN-A are specifically designed for use in bonded waterproofing assemblies, such as wet rooms, bathroom floors, and other applications that require waterproofing and drainage.

8.2 Schluter®-KERDI-DRAIN-F is a floor drain specifically designed to allow connections to Schluter®-DITRA, DITRA-XL, DITRA-HEAT, and DITRA-HEAT-DUO uncoupling membranes. KERDI-DRAIN-F consists of a drain body and adjustable grate assembly that accommodates a wide range of tile thicknesses.

The drain body is available in polypropylene or stainless steel, each with a laminated Schluter®-KERDI collar that ensures a simple connection to the uncoupling membrane on the floor and at wall transitions. The polypropylene drain features a 2" (50 mm) NPT outlet and is supplied with PVC and ABS couplings for simple attachment to the pipe using an appropriate solvent cement. The stainless steel drains are available with standard 2" (50 mm) no-hub and threaded outlets. The no-hub outlets are attached to the pipe using an appropriate mechanical (e.g., flexible or no-hub) coupling. The threaded outlets are attached to the pipe using thread sealing tape or compound. The simple connection to standard drain outlets makes KERDI-DRAIN-F suitable for new construction and renovation/remodeling projects.

The KERDI-DRAIN-F grate assembly consists of a frame, which can be seamlessly adjusted to the thickness of the ceramic tile or stone



8.2 Schluter®-KERDI-DRAIN-F

covering via the vertical height adjustment collar and grates that are placed within the frame. The 4" (100 mm) standard grate assembly frame features an approximately 1/8" (3 mm) wide reveal after installation, and grate/frame combinations are available in stainless steel in CLASSIC design or anodized aluminum in CONTOUR design, both available in a variety of finishes. The 4" (100 mm) KERDI-DRAIN-STYLE grate assembly frame features a minimal reveal after installation. It is made of brushed stainless steel and can be combined with one of three grate design options: FLORAL (E), CURVE (F), or PURE (G). Various metallic and color-coated finishes are available. Please note that the 4" (100 mm) TILE grate and the 6" (150 mm) square and round grates and clean out cover are not compatible with KERDI-DRAIN-F.

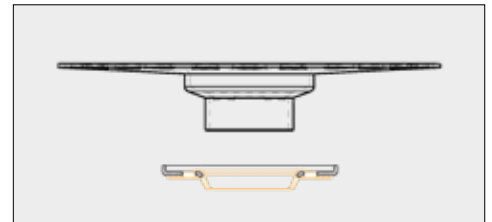

8.2 Schluter®-KERDI-DRAIN-A

8.2 Schluter®-KERDI-DRAIN-A adaptor kits are designed to convert clamping ring drains to integrated bonding flange drains when removal of the clamping ring drain is not practical (e.g., when they are set in concrete slabs).

The adaptor kit includes a stainless steel adaptor ring, available in 5-1/4" (133 mm) and 7-1/2" (191 mm) diameter sizes, with an over-molded rubber gasket and a variety of perforated hole patterns that align with most common clamping ring drains. The adaptor ring replaces the clamping ring and is attached to the existing drain body using the clamping ring bolts. This connection is made watertight via the rubber gasket and Schluter®-KERDI-FIX adhesive/sealant. The adaptor drain with integrated bonding flange slides into the adaptor ring with the over-molded rubber gasket ensuring a watertight seal.

Grate assemblies consist of a frame, which can be seamlessly adjusted to the thickness and layout of the ceramic tile or stone covering via the height adjustment collar and lateral adjustment ring and grates or cleanout covers that are placed within the frame. The 4" (100 mm) standard grate assembly frame features an approximately 1/8" (3 mm) wide reveal after installation, and grate/frame combinations are available in stainless steel in CLASSIC design or anodized aluminum in CONTOUR design, both available in a variety of finishes. The 4" (100 mm) KERDI-DRAIN-STYLE grate assembly frame features a minimal reveal after installation. It is made of brushed stainless steel and can be combined with one of three grate design options: FLORAL (E), CURVE (F), or PURE (G). Various metallic and color-coated finishes are available. The 4" (100 mm) TILE grate is a square stainless steel plate with KERDI laminated on the surface to allow for bonding of ceramic or stone tile, which creates a virtually invisible drainage line. The 6" (150 mm) square and round stainless steel grate assembly frames feature an approximately 3/16" (5 mm) wide reveal after installation and can be combined with stainless steel grates in CLASSIC design or a square clean out cover.

Notes:

- The 4" (100 mm) TILE grate and the 6" (150 mm) square and round grates and clean out cover are not compatible with the 5-1/4" (133 mm) adaptor kits.
- The 6" (150 mm) grate assemblies and grate assemblies used with the 5-1/4" (133.4 mm) adaptor kits only allow vertical and tilt adjustment (no lateral adjustment).

Material Properties and Areas of Application

KERDI-DRAIN-F and KERDI-DRAIN-A are suitable for use in residential and commercial applications, including areas subject to foot and wheelchair traffic, such as bathrooms, laundry rooms and wet rooms in homes, hotels, schools, healthcare facilities, etc.

KERDI-DRAIN-F is listed by UPC® (File No. 4591), CSA (File No. 211355), and ICC-ES (Report No. PMG-1204).

KERDI-DRAIN-F drain bodies are formed using polypropylene or stainless steel 304 (1.4301 = V2A). Polypropylene flanges are supplied with ABS and PVC couplings. The KERDI-DRAIN-A adaptor kits feature adaptor rings made of stainless steel 304 (1.4301 = V2A) with thermoplastic rubber gaskets and adaptor flanges made of ABS. Drain grates are available in plain and coated stainless steel 304 (1.4301 = V2A) and anodized aluminum. The covering

support is stainless steel 304 (1.4301 = V2A) with KERDI laminated on the surface.

Schluter®-Systems drain grates are resistant to most chemicals encountered in tiled environments. In special cases, the suitability of a proposed type of material must be verified based on the anticipated chemical, mechanical, and/or other stresses. In general, grates should be protected against abrasion or scratching. Exceptions and special considerations are listed below.

Stainless steel can sustain high mechanical stresses and is particularly well suited for applications requiring resistance against chemicals and acids. For more severe chemical exposure, such as de-icing salts and chemicals used in swimming pools, we recommend the use of stainless steel 316 L, which offers even higher corrosion resistance than the 304. Even stainless steel cannot withstand all chemical exposures, such as hydrochloric acid, hydrofluoric acid or certain chlorine, chloride and brine concentrations.

Metallic-coated grates are stainless steel 304 with a metallic coating created using physical vapor deposition (PVD). The resulting metallic film is very hard and corrosion-resistant.

Textured color-coated grates are stainless steel with a powder coat.

Anodized aluminum grates feature an anodized layer that retains a uniform appearance during normal use. The surface may be damaged by grout or setting material. Therefore, these materials must be removed immediately.

Installation

The installation instructions below represent the use of KERDI-DRAIN-F and KERDI-DRAIN-A in floor applications. Installation instructions for use of KERDI-DRAIN-A in shower applications can be found in the Schluter®-Shower System Installation Handbook.

KERDI-DRAIN-F

Following the instructions below will help ensure the polypropylene bonding flange is flush with the surface of the surrounding DITRA uncoupling membrane. Adjustments to the drain elevation may be required when using the thinner stainless steel bonding flange or thicker DITRA-HEAT, DITRA-XL, or DITRA-HEAT-DUO uncoupling membrane.

Preparation

After locating the correct position, cut a 4" (100 mm) diameter hole in the substrate for the drain outlet and coupling to the waste line using the template provided.

Note: Fill in box-outs in concrete floors with dry-pack mortar or concrete. A pipe coupling or similar can be used as a form around the waste line. Select form to accommodate the drain outlet and coupling (when applicable). Limit the diameter of the hole to 4-1/4" (108 mm) maximum to ensure proper support of the tile assembly. A larger hole can lead to lack of support and damage (e.g., cracked grout).

Drain installation

When there is access to plumbing from below

1. If utilizing the polypropylene drain body, connect the included ABS or PVC coupling (select according to waste line material) to the drain outlet using thread sealing tape or compound.
2. Apply thin-set mortar up to the hole in the substrate using the same notched trowel as will be used for the uncoupling membrane installation.
3. Solidly embed the bonding flange in the mortar and check for level.
4. Install the construction cover to protect the attached KERDI collar and prevent debris from falling into the drain.

When there is no access to plumbing from below

1. If utilizing the polypropylene drain body, connect the included ABS or PVC coupling (select according to waste line material) to the drain outlet using thread sealing tape or compound.
2. Place the drain body on the subfloor to measure and cut a section of pipe to connect the drain to the odor trap.
3. Apply thin-set mortar up to the hole in the substrate using the same notched trowel as will be used for the uncoupling membrane installation.
4. Prepare the odor trap, cut section of pipe, and drain with cleaner, primer and ABS or PVC cement per the solvent cement manufacturer's instructions.
5. Connect the drain to the odor trap and solidly embed in the mortar; check for level.
6. Install the construction cover to protect the attached KERDI collar and prevent debris from falling into the drain.

Notes:

- Use a no-hub coupling for stainless steel drains with no-hub outlets and thread sealing tape or compound for stainless steel drains with threaded outlets.
- Schluter Systems recommends the use of a trap primer in low use drain applications to prevent the trap from drying out and the potential for odors from sewer gas escaping the waste line.
- Schluter Systems strongly recommends a leak test be performed on the connection between the drain and

waste line prior to continuing with the remainder of the installation whenever possible. Refer to local plumbing and/or building codes for any specific requirements in your area.

DITRA or DITRA-HEAT Installation

Please see the DITRA or DITRA-HEAT Installation Handbook for installation details and instructions.

1. Install membrane up to the outer edge of the bonding flange (template provided).
2. Fill the membrane with a Schluter® thin-set mortar or unmodified thin-set mortar around the drain, approximately 3" (76 mm) wide.
3. Comb additional mortar using a 1/4" x 3/16" (6 mm x 5 mm) V-notched trowel or the Schluter®-KERDI trowel, which features a 1/8" x 1/8" (3 mm x 3 mm) square-notched design.
4. Solidly embed the attached KERDI collar into the mortar with the flat side of the trowel to ensure full coverage and remove air pockets.

Grate Assembly

1. Snap the grate frame into the vertical height adjustment collar.
2. Butter the underside of the grate frame with thin-set mortar to ensure full support.
3. Place the grate assembly into the flange and install the surrounding tiles.
4. Press the grate flush with the tile surface. Remove all excess setting material immediately.

Notes:

- Protect the visible surface of the grate from contact with setting and grouting materials. In particular, anodized aluminum is sensitive to alkaline materials.
- For acid-resistant coverings, use an epoxy adhesive to set and grout the tile.

KERDI-DRAIN-A

Drain Installation

1. Remove the clamping ring from the installed drain and save the bolts for installation of the adaptor ring. Align the bolt pattern of the clamping ring with the matching punch-outs in the adaptor ring. Punch the matching inserts out through the stainless steel adaptor ring.
2. Apply a continuous 1/4" - 3/8" (6 mm - 10 mm) bead of KERDI-FIX to the underside of the adaptor ring. Align the holes in the adaptor ring with the bolt holes in the installed drain and place the adaptor ring on the installed clamping ring drain. Re-insert and tighten the bolts using a star

pattern. Bolts are to be finger-tight plus 1/4 turn; do not overtighten, as this may warp the adaptor ring and result in leaks.

3. Slide the adaptor drain body into the adaptor ring and ensure full support under the bonding flange with mortar. The substrate preparation must be such that it is flush with the top of the bonding flange. For example, a mortar bed can be applied using the bonding flange and mortar screeds as guides.

Notes:

- Schluter Systems recommends the use of a trap primer in low use drain applications to prevent the trap from drying out and the potential for odors from sewer gas escaping the waste line.
- Schluter Systems strongly recommends a leak test be performed on the connection between the drain and waste line prior to continuing with the remainder of the installation whenever possible. Refer to local plumbing and/or building codes for any specific requirements in your area.

DITRA or DITRA-HEAT Installation

Please see the DITRA or DITRA-HEAT Installation Handbook for installation details and instructions.

1. Install membrane up to the outer edge of the bonding flange (template provided).
2. The membrane is sealed to the bonding flange using a cut section of the KERDI membrane. The KERDI is carried to the step in the bonding flange (template provided) and must overlap the DITRA or DITRA-XL membrane by a minimum of 2" (50 mm).
3. Fill the membrane with a Schluter thin-set mortar or unmodified thin-set mortar around the drain, approximately 3" (76 mm) wide.
4. Apply thin-set mortar to the bonding flange and surrounding membrane with a 1/4" x 3/16" (6 mm x 5 mm) V-notched trowel or the KERDI-TROWEL, which features a 1/8" x 1/8" (3 mm x 3 mm) square-notched design.
5. Solidly embed the attached KERDI into the mortar with the flat side of the trowel to ensure full coverage and remove air pockets.

Grate Assembly

Grates

1. Place the height adjustment collar inside the lateral adjustment ring and snap the grate frame into place. Note: For drains with 6" (150 mm) grates, the height adjustment collar is integrated with the grate. For the 5-1/4" (133 mm) adaptor kit, there is no lateral adjustment ring.
2. Fill the step in the bonding flange with

Schluter thin-set mortar or unmodified thin-set mortar and back-butter the underside of the grate frame to ensure full support.

3. Press the assembly into the mortar and install the surrounding tiles, ensuring full coverage.
4. Position the grate to match the joint pattern of the tile covering and press flush with the tile surface. Remove all excess setting material.

Notes:

- Protect the visible surface of the grate from contact with setting and grouting materials. In particular, anodized aluminum is sensitive to alkaline materials.
- For acid-resistant coverings, use an epoxy adhesive to set and grout the tile.

Tileable Covering Support

1. Place the tile spacer inside the lateral adjustment ring.
2. Fill the step in the bonding flange with Schluter thin-set mortar or unmodified thin-set mortar and press the assembly into the mortar.
3. Install the surrounding tiles up to the tile spacer and the integrated tabs on the lateral adjustment ring, which provide for a flush transition to the covering support. Remove all excess setting material. Position the tile spacer to match the joint pattern of the tile covering.
4. Apply tile to the top of the covering support. The tile may overhang the covering support provided that a drainage opening of at least 3/16" (5 mm) is provided.
5. Once the assembly has been set and grouted, remove the tile spacer and insert the tiled covering support in the lateral adjustment ring.

Notes:

- For acid-resistant coverings, use an epoxy adhesive to set and grout the tile.
- The tileable covering support is not compatible with the 5-1/4" (133 mm) adaptor kits.

Maintenance

KERDI-DRAIN-F and KERDI-DRAIN-A require no special maintenance and are resistant to mold and fungi. The grate may be removed to clean the drain housing and the drain pipes.

Clean the grates and profiles using pH neutral cleaners. Avoid the use of strong acids (e.g., hydrochloric, hydrofluoric) and bases/alkaline cleaners (e.g., bleach, ammonia, chlorides). Do not use abrasive cleaning agents and tools. Even stainless steel requires periodic cleaning, which will maintain a neat appearance and reduce the risk of corrosion. Stainless steel surfaces develop a sheen when treated with a chrome-polishing agent.

Product Item Numbers

Schluter®-KERDI-DRAIN-A

ADAPTOR KIT — 5-1/4" or 7-1/2" ADAPTOR RING

Schluter®-KERDI-DRAIN-A ADAPTOR KITS are used to convert traditional clamping ring drains to integrated bonding flange drains when removal of the clamping ring drain is not practical. A stainless steel adaptor ring with an overmolded rubber gasket replaces the clamping ring and is sealed to the existing drain body using Schluter®-KERDI-FIX. The bonding flange then slides into the adaptor ring and seals against the rubber gasket. Adaptor kits are suitable for both mortar bed and Schluter®-KERDI-SHOWER-T/-TS/-TT shower tray applications.

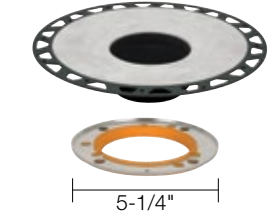
5-1/4" (133.4 mm) adaptor ring	
Flange and ring	Item No.
 <p>Also included: Height adjustment collar for KERDI-DRAIN grate</p>	KDA5 FLK ABS

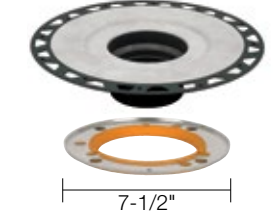
7-1/2" (191 mm) adaptor ring	
Flange and ring	Item No.
 <p>Also included: Lateral adjustment ring for KERDI-DRAIN grate</p>	KDA7 FLK ABS

Additional components included

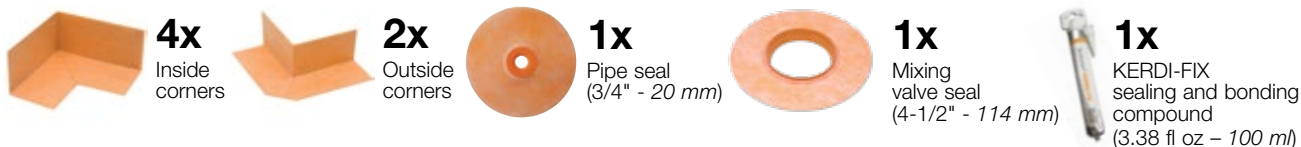

Flange and adaptor ring measurements	
	5-1/4"
A	11-13/16" - 300 mm
B	2-13/32" - 60.7 mm
C	2-23/32" - 69.3 mm
D	5-1/4" - 133.4 mm
E	2-29/32" - 74 mm
F	1-1/64" - 25.9 mm
G	2-1/16" - 52.6 mm

Flange and adaptor ring measurements	
	7-1/2"
A	11-13/16" - 300 mm
B	4-13/32" - 111.8 mm
C	4-11/16" - 118.9 mm
D	7-1/2" - 191 mm
E	5-7/64" - 130 mm
F	3-1/16" - 77.8 mm
G	3-41/64" - 92.4 mm



The TILE grate and the 6" round/square grates and clean out cover are not compatible with the 5-1/4" ring flange.

Schluter®-KERDI-DRAIN-F

FLOOR DRAIN WITH INTEGRATED KERDI COLLAR

Schluter®-KERDI-DRAIN-F is a floor drain specifically designed to allow connections to Schluter®-DITRA and DITRA-HEAT uncoupling membranes in floor applications. The drain body is available in polypropylene or stainless steel, each with a laminated Schluter®-KERDI collar that ensures a simple connection to the uncoupling membrane on the floor and at wall transitions. KERDI-DRAIN-F features a flat, narrow bonding flange to allow for placement against walls or in corners on floors. It can be combined with virtually any KERDI-DRAIN grate assembly, with the exception of the tileable grate and the 6" (150 mm) square and round grates. The grate assembly is sold separately.

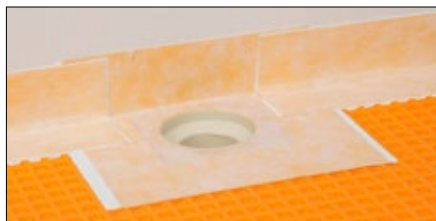

Schluter®-KERDI-DRAIN-F - Floor drain with narrow bonding flange and integrated KERDI collar

Polypropylene

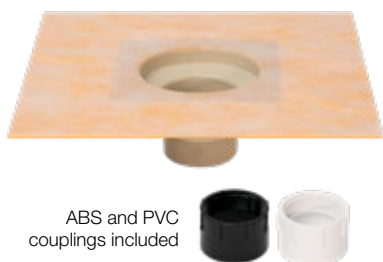

ABS and PVC couplings included

Stainless steel with no-hub outlet



Stainless steel with threaded outlet

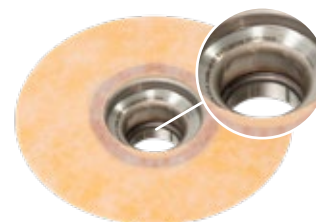

Material	Outlet	Item No.
Polypropylene	50 mm - 2" NPT	KDF2FL
Stainless Steel	50 mm - 2" no-hub	KDF2EFL
Stainless Steel	50 mm - 2" threaded	KDF2ETHFL

Listed by ICC-ES (Report No. PMG-1204), UPC® and CSA.

Additional components included



1x

Vertical height adjustment collar



1x

Construction cover

i

The TILE grate and the 6" (150 mm) round/square grates and clean out cover are not compatible with KERDI-DRAIN-F.

Drain measurements

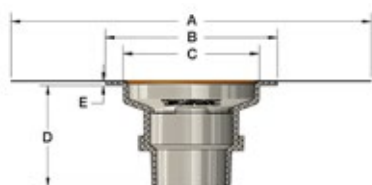

Polypropylene 50 mm (2") outlet

A	268 mm - 10-9/16"
B	128 mm - 5-1/32"
C	101.1 mm - 3-31/32"
D	75.4 mm - 2-31/32"
E	3 mm - 1/8"

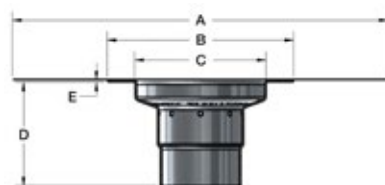

Stainless steel 50 mm (2") no-hub outlet

A	280 mm - 11-1/32"
B	139 mm - 5-15/32"
C	98 mm - 3-27/32"
D	77.2 mm - 3-1/32"
E	1.5 mm - 1/16"

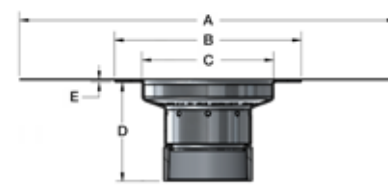

Stainless steel 50 mm (2") threaded outlet

A	280 mm - 11-1/32"
B	139 mm - 5-15/32"
C	98 mm - 3-27/32"
D	73.7 mm - 2-29/32"
E	1.5 mm - 1/16"

Schluter®-KERDI-DRAIN-STYLE

4" (100 mm) GRATES

Stainless Steel

PURE	
Grate finish	Item No.
Brushed stainless steel (EB)	KDIF4 GRK EB D8
Brushed nickel (EBT)	KDIF4 GRK EBT D8
Brushed rose gold (EBRG)	KDIF4 GRK EBRG D8
Brushed vintage gold (EBVG)	KDIF4 GRK EBVG D8
Brushed classic gold (EBCG)	KDIF4 GRK EBCG D8



CURVE	
Grate finish	Item No.
Brushed stainless steel (EB)	KDIF4 GRK EB D6
Brushed nickel (EBT)	KDIF4 GRK EBT D6
Brushed rose gold (EBRG)	KDIF4 GRK EBRG D6
Brushed vintage gold (EBVG)	KDIF4 GRK EBVG D6
Brushed classic gold (EBCG)	KDIF4 GRK EBCG D6



FLORAL	
Grate finish	Item No.
Brushed stainless steel (EB)	KDIF4 GRK EB D5
Brushed nickel (EBT)	KDIF4 GRK EBT D5
Brushed rose gold (EBRG)	KDIF4 GRK EBRG D5
Brushed vintage gold (EBVG)	KDIF4 GRK EBVG D5
Brushed classic gold (EBCG)	KDIF4 GRK EBCG D5

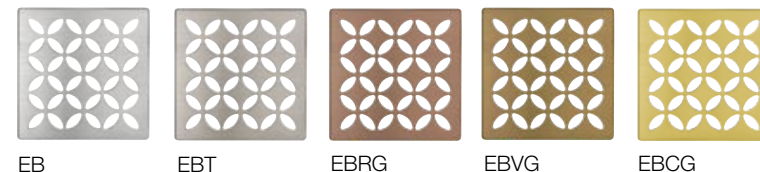

Contents



1x
Grate and frame



1x
Height adjustment collar



1x
Lateral adjustment ring

Schluter®-KERDI-DRAIN-STYLE

4" (100 mm) GRATES

TRENDLINE

PURE	
Grate finish	Item No.
Matte white (MBW)	KDIF4 GRK MBW D8
Ivory (TSI)	KDIF4 GRK TSI D8
Greige (TSBG)	KDIF4 GRK TSBG D8
Cream (TSC)	KDIF4 GRK TSC D8
Bronze (TSOB)	KDIF4 GRK TSOB D8
Stone grey (TSSG)	KDIF4 GRK TSSG D8
Pewter (TSG)	KDIF4 GRK TSG D8
Dark anthracite (TSDA)	KDIF4 GRK TSDA D8
Matte black (MGS)	KDIF4 GRK MGS D8

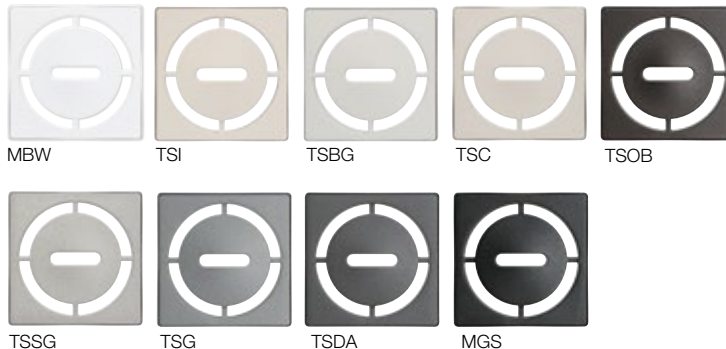

CURVE	
Grate finish	Item No.
Matte white (MBW)	KDIF4 GRK MBW D6
Ivory (TSI)	KDIF4 GRK TSI D6
Greige (TSBG)	KDIF4 GRK TSBG D6
Cream (TSC)	KDIF4 GRK TSC D6
Bronze (TSOB)	KDIF4 GRK TSOB D6
Stone grey (TSSG)	KDIF4 GRK TSSG D6
Pewter (TSG)	KDIF4 GRK TSG D6
Dark anthracite (TSDA)	KDIF4 GRK TSDA D6
Matte black (MGS)	KDIF4 GRK MGS D6

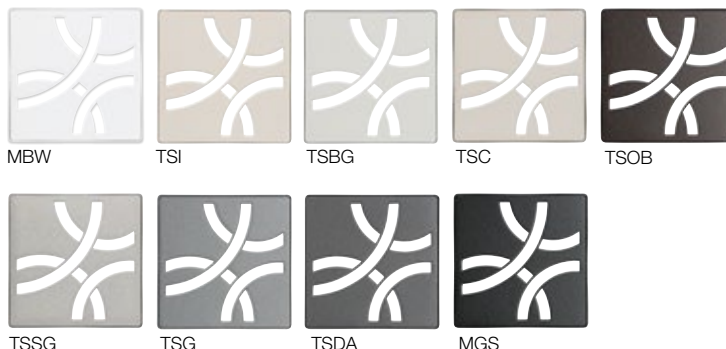

FLORAL	
Grate finish	Item No.
Matte white (MBW)	KDIF4 GRK MBW D5
Ivory (TSI)	KDIF4 GRK TSI D5
Greige (TSBG)	KDIF4 GRK TSBG D5
Cream (TSC)	KDIF4 GRK TSC D5
Bronze (TSOB)	KDIF4 GRK TSOB D5
Stone grey (TSSG)	KDIF4 GRK TSSG D5
Pewter (TSG)	KDIF4 GRK TSG D5
Dark anthracite (TSDA)	KDIF4 GRK TSDA D5
Matte black (MGS)	KDIF4 GRK MGS D5

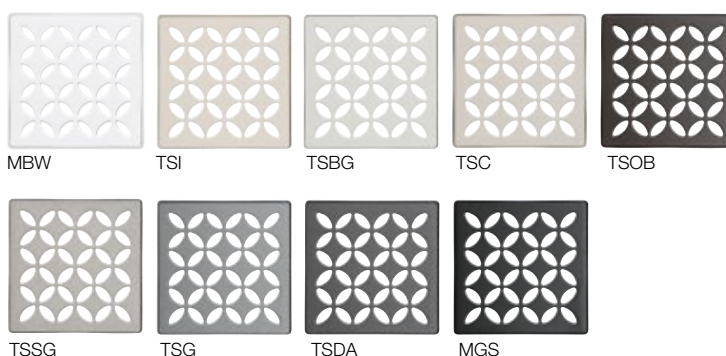

Contents



1x
Grate and frame



1x
Height adjustment collar



1x
Lateral adjustment ring



Schluter®-KERDI-DRAIN

4" (100 mm) GRATES

Stainless steel - CLASSIC

CLASSIC	
Grate finish	Item No.
Stainless steel (E)	KD4 GRK E
Chrome (EP)	KD4 GRK EP
Oil-rubbed bronze (EOB)	KD4 GRK EOB
Nickel (ET)	KD4 GRK ET
Rose gold (ERG)	KD4 GRK ERG
Vintage gold (EVG)	KD4 GRK EVG
Classic gold (ECG)	KD4 GRK ECG



Anodized aluminum - CONTOUR

CONTOUR	
Grate finish	Item No.
Brushed nickel (ATGB)	KD4 GRK ATGB
Brushed copper (AKGB)	KD4 GRK AKGB
Brushed brass (AMGB)	KD4 GRK AMGB

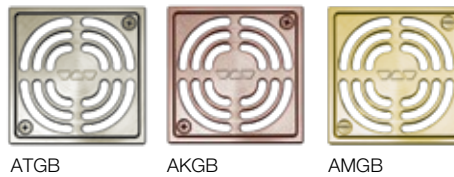

Contents



1x
Grate and frame



1x
Height adjustment collar



1x
Lateral adjustment ring

Schluter®-KERDI-DRAIN

4" (100 mm) GRATES

TILE

TILE	
Grate finish	Item No.
TILE	KD4 GRK ECS



Contents	
	1x Tileable covering support
	1x Spacer
	1x Lateral adjustment ring





The tileable grate is not suitable for use with the KERDI-DRAIN-F flange and the KERDI-DRAIN-A flange with 5-1/4" (133.4 mm) adaptor ring.

6" (150 mm) GRATES

Stainless steel - CLASSIC

CLASSIC SQUARE	
Grate finish	Item No.
Stainless steel (E)	KD6 GRK E



Contents	
	1x Grate and frame with integrated height adjustment collar
	1x Lateral adjustment ring









CLASSIC ROUND	
Grate finish	Item No.
Stainless steel (E)	KD6 GRK RE



The 6" (150 mm) grates are not suitable for use with the KERDI-DRAIN-F flange and the KERDI-DRAIN-A flange with 5-1/4" (133.4 mm) adaptor ring.

ADAPTOR KIT — 5-1/4" ADAPTOR RING - 4" STAINLESS STEEL GRATE

5-1/4" (133.4 mm) adaptor ring	
4" (100 mm) square grate	
Stainless steel	KDAR/ABS/E

Contents							
	1x Flange		1x Grate and frame		1x Height adjustment collar		1x Adaptor ring
	4x Inside corners		2x Outside corners		1x Pipe seal (3/4" - 20 mm)		1x Mixing valve seal (4-1/2" - 114 mm)
	1x KERDI-FIX sealing and bonding compound (3.38 fl oz - 100 ml)						

10 PACKS — ADAPTOR KIT - 5-1/4" ADAPTOR RING

5-1/4" (133.4 mm) adaptor ring	
Flange and ring	Item No.
<p>5-1/4"</p> <p>Also included: Height adjustment collar for KERDI-DRAIN grate</p>	KDA5 FLK ABS 10

Additional components included	
<p>40x Inside corners</p>	<p>20x Outside corners</p>
<p>10x Pipe seal (3/4" - 20 mm)</p>	<p>10x Mixing valve seal (4-1/2" - 114 mm)</p>
<p>10x KERDI-FIX sealing and bonding compound (3.38 fl oz - 100 ml)</p>	

Note: 10 packs are packaged in bulk, not individually boxed.



The TILE grate and the 6" round/square grates and clean out cover are not compatible with the 5-1/4" ring flange.

10 PACKS — 4" GRATE - STAINLESS STEEL

Stainless steel - CLASSIC



Stainless steel
Item No.
KD4 GRK E 10

Note: 10 packs are packaged in bulk, not individually boxed.

Contents	
<p>10x Grate and frame</p>	<p>10x Height adjustment collar</p>
<p>10x Lateral adjustment ring</p>	

Schluter®-KERDI-DRAIN

6" SQUARE CLEAN OUT COVER

The **Schluter®-KERDI-DRAIN Clean Out Cover** is a 6" stainless steel cover available for installations where the KERDI-DRAIN bonding flange is to be used in a cleanout application.



The clean out cover is not compatible with KERDI-DRAIN-F and KERDI-DRAIN-A with 5-1/4" ring flange.

Clean out cover 6"	
Item No.	Finish
KD-GR6C-E	Stainless steel

TAMPER PROOF SCREWS

Schluter®-KERDI-DRAIN Tamper Proof Screws are designed as a high security accessory for the KERDI-DRAIN. Ideal for loss prevention and anti-theft, these tamper proof screws are used in environments where tamper resistance is desired or required (e.g., healthcare or education facilities, etc.). Phillips head screws are included with the KERDI-DRAIN. The tamper-proof screws as well as the driver bit must be purchased separately.



Tamper proof screw and driver bit	
Item No.	Description
KD/TPSCRW	Tamper proof screw
KD/TPWRCH	Driver bit

Schluter®-Systems Floor Drains 10-Year Limited Warranty

COVERAGE AND CONDITIONS: Subject to the conditions and limitations as stated hereinafter, **Schluter®-Systems*** warrants that **Schluter®-KERDI-DRAIN-F** or **Schluter®-KERDI-DRAIN-A** (the "**Product**") will be free from manufacturing defects, and will not rot, deteriorate or break down under normal use for a period of ten (10) years from the date of purchase only when the Product is used and installed in accordance with the terms and conditions of the Schluter-Systems Floor Drains Technical Data Sheet and industry standard guidelines that are not in conflict with the Data Sheet in effect at the time of installation. It is the responsibility of the owner/ builder/ installer to ensure the suitability of all building materials and all associated building materials for the owner's intended use. It is recommended that the owner consult with an experienced and professional installer.

RESOLUTION: If the Product fails to meet this warranty, then the owner's exclusive remedy and the sole obligation of Schluter-Systems, at its election, shall be to a) replace the failed Product or b) pay an amount not to exceed the original cost of the Product verified to be defective. When Schluter®-KERDI-DRAIN-F or Schluter®-KERDI-DRAIN-A is installed in conjunction with Schluter®-DITRA, Schluter®-DITRA-HEAT/-PS, Schluter®-DITRA-HEAT-DUO/-PS or Schluter®-KERDI membranes, the assembly qualifies for the Schluter-DITRA & Schluter®-DITRA-XL 10-Year Limited Warranty, Schluter®-DITRA-HEAT & Schluter®-DITRA-HEAT-DUO 10-Year Limited Warranty, Schluter-KERDI & Schluter-KERDI-DS 10-Year Limited Warranty, Schluter®-DITRA-HEAT & Schluter®-DITRA-HEAT-DUO 10-Year Limited Warranty, or Schluter®-Shower System 10-Year Limited Warranty. The warranties referenced above cover the entire covering assembly. Refer to the Schluter®-DITRA Installation Handbook, Schluter®-DITRA-HEAT Installation Handbook, Schluter®-DITRA-HEAT Technical Data Sheet, Schluter® Waterproofing Membranes Technical Data Sheet, and Schluter®-Shower System Installation Handbook for details and applicable warranty information.

DISCLAIMER: There are no warranties beyond this expressed warranty as stated above. All other warranties, representations or conditions, expressed or implied, are disclaimed and excluded, including warranties, representations or conditions of **MERCHANTABILITY** or **FITNESS FOR A PARTICULAR PURPOSE** arising by statute or otherwise by law or from a course of dealing or usage of trade. Schluter-Systems excludes and in no event shall have any liability for lost profits or any other indirect, special, incidental, punitive, exemplary, or consequential damages, arising out of or otherwise connected to failure of the product or flooring system of which it is part, nor misuse of the product or flooring system, regardless of any strict liability, active or passive negligence of Schluter-Systems, and regardless of the legal theory (contract or tort or extra-contractual or other), nor from acts of war, terrorism, faulty and negligent penetration of the system, fires, explosions, acts of God, intentional acts of destruction or any losses due to structural failure or other causes unrelated to the product or delays, or any other incidental or consequential damages. This warranty is given in lieu of any other warranty expressed or implied. The remedies contained herein are the only remedies available for breach of this warranty. This limited warranty gives you specific legal rights; some states and provinces do not allow disclaimers or other restrictions of implied warranties, so some of the above disclaimers may not apply to you. **No changes or modification of any terms or conditions of this warranty are allowed unless authorized by written agreement and signed by the Technical Services Director or an Officer of Schluter-Systems.** For the most current information and materials regarding Schluter-Systems warranties and programs, please visit [Schluter.com/downloadfiles](https://www.schluter.com/downloadfiles).

TRANSFERABILITY: This Limited Warranty extends ONLY to the original end user (defined as original intended owner and user of the property/unit in which the installation is incorporated - herein referred to as "**Owner**") and is not transferable or assignable, unless approved in writing by the Technical Services Director or an Officer of Schluter-Systems or otherwise prohibited by specific state or provincial law.

EFFECTIVE DATE: This warranty shall supersede and replace any and all prior oral or written warranties, agreements, or other such representations made by or on behalf of Schluter-Systems relative to the Product or the application of the Product and shall apply to any installation occurring on or after January 30, 2024

CLAIMS ON THIS LIMITED WARRANTY: To make a claim under this Limited Warranty, the Owner must provide Schluter-Systems with written notice within 30 days of any alleged defect in the Product covered by this Limited Warranty, together with date and proof of purchase of the Product, proof of the costs of the original installation and name and address of all installers, failing which this Limited Warranty shall be of no legal effect. Schluter-Systems reserves the right at its election and as a condition of this Limited Warranty to inspect the alleged failed and defective condition.

All U.S. Claims shall be sent to:

Schluter Systems L.P.
Attn: Warranty Claims Dept.
194 Pleasant Ridge Road
Plattsburgh, NY 12901-5841

All Canadian Claims shall be sent to:

Schluter Systems (Canada), Inc.
Attn: Warranty Claims Dept.
21100 chemin Ste-Marie
Ste-Anne-de-Bellevue, QC H9X 3Y8

*For the purpose of this warranty **Schluter Systems, L.P.** shall provide the warranty for all products for end users located in the United States, and **Schluter Systems (Canada) Inc.** shall provide the warranty for all products for end users located in Canada. This warranty is limited to sales of the Product made in and intended for use in the United States and Canada.

